

MicroIQ Mobile

BLE Self Latching

RB
series

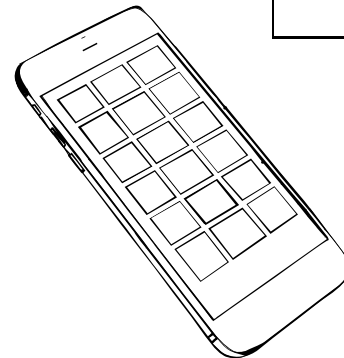
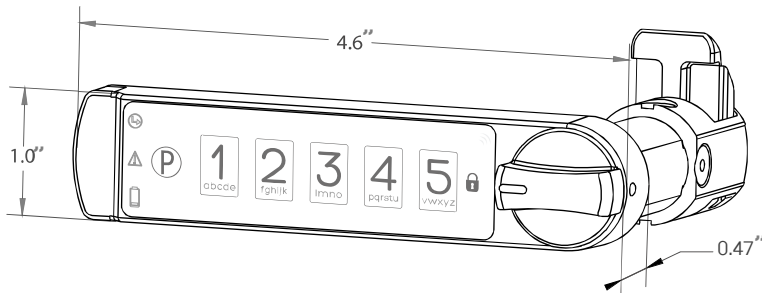

Installation and Set up

- Wireless installation takes less than 5 minutes
- Easily learn in hundreds of users
- Assign access parameters for each lock, employee, group, and location
- Fits into standard double-D key lock holes
- Secured coin cell battery is conveniently accessed from the outside of the lock
- Operates in station mode (repeated use)

Technology

- Access with your existing smartphone
- Manage access with MicroTraq, ProxTraq, and MobilTraq app/portals
- Enterprise security administration from a single portal
- Generate audit trails to track user activity and lock/unlock attempts
- Remote enrollment of users

Specifications

Dimensions: 4.6" w x 0.47d x 1.01" h	Power: CR2032 coin cell battery
Network data communication: Bluetooth	Battery life: 1-2 years
Compatible smartphones: All common standards including Android 5.X, IOS 11 or higher.	Operating modes: (1) <u>Station Mode</u> : The lock is accessed by one or more users repeatedly. The lock memory retains codes until these codes are intentionally erased or replaced
# of Users: Each lock can store hundreds of users	Keypad: 5 Digit
Levels of access: master (6 digits), supervisor (3-6 digits), and user (3-6 digits)	Operating temperature: 32° - 122°
Locking Mechanism: 4 position adjustable spring bolt, push to close with automatic latching	Storage temperature: 14° to 158°
Shell length: 7/8", 1-3/4", and 2-13/64"	Operating moisture: 20% - 80% Rh
Knob rotation: 90 degrees clockwise or counterclockwise	Interference: Immune to physical shock and magnetic field
Locking position: one or two	Cleaning: withstand bleach and chemical cleaners

Mounting details:

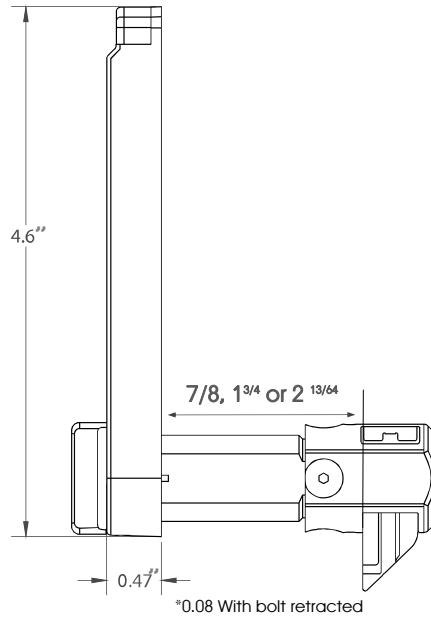

MOUNTING HOLE DETAILS

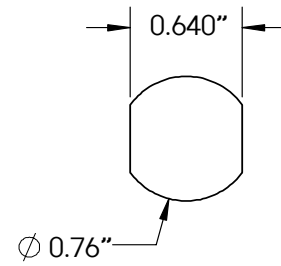

Flats can be parallel or perpendicular to the lock.

Orientation options:

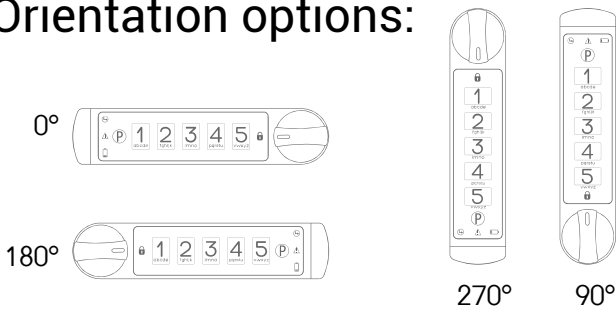

Knob options:

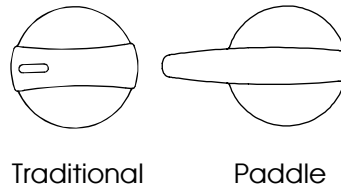

Power:

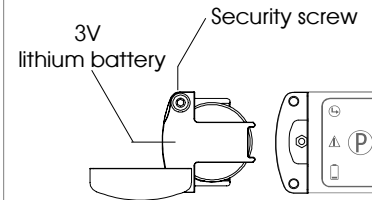

Lock management via ProxTraq Bluetooth and cloud database:

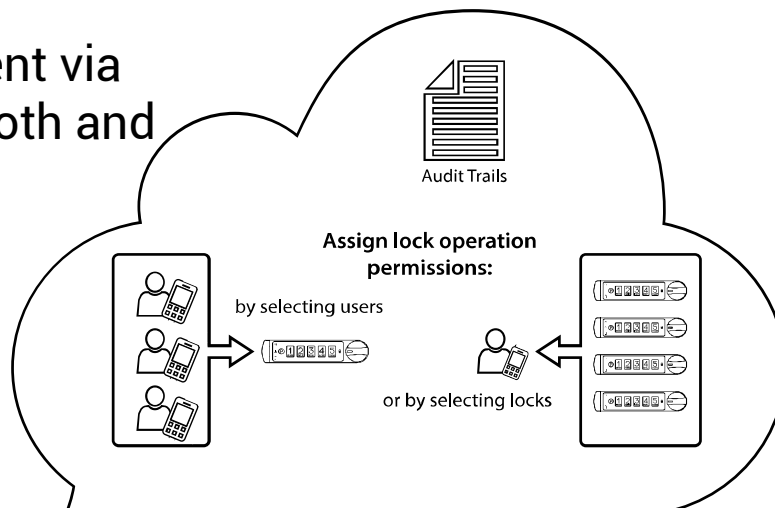

Remote administration:

- Manage locks
- Manage users
- View audit trails



Mobile Network Bridge



Handheld devices operating the **MicroIQ** app are used to upload audit trails and update access permissions